

---

---

# **Trampoline and Enclosure User Manual**

For all round Propel Trampoline models



**Assembly, Installation, Care, Maintenance,  
and User Instructions**



**WARNING**



**READ THESE MATERIALS PRIOR TO ASSEMBLING AND  
USING THIS TRAMPOLINE AND ENCLOSURE.**

**Failure to assemble and use this trampoline and enclosure net combination as specified in this manual will automatically void the warranty.**

Do Not return this product to the store. Instead, please visit our website at [www.PropelTrampolines.com](http://www.PropelTrampolines.com) where you will find our current contact information. Our friendly customer service staff can help you with any problems or questions that may arise during the assembly, installation, use, maintenance, or obtainment of replacement parts for your Trampoline.

This trampoline and included safety enclosure net meets or exceeds the standards of the American Society for Testing and Materials.



Read all assembly, care, maintenance, and user instructions in this manual prior to assembling and using this trampoline and enclosure net combination.

Please save this manual for future reference and check our website for the latest manual revisions.

### **LIABILITY DISCLAIMER:**

While every attempt is made to embody the highest degree of protection in all equipment, we cannot guarantee freedom from injury. The user assumes all risk of injury due to use, assembly, or transportation. All merchandise is sold on this condition. No representative of the company can waive or change disclaimer condition.

#### Warning

This trampoline and enclosure net combination is intended to be used by only one person at a time, weighing not more than; 300 lbs. (15 foot), 275 lbs. (14 foot), 250 lbs. (12 foot), 225 lbs. (10 foot), or 200 lbs. (7-8 foot).

# TABLE OF CONTENTS

BEFORE YOU BEGIN -	4
INSTRUCTIONAL MATERIAL AND RULES FOR USE -	5
OVERVIEW OF TRAMPOLINE AND ENCLOSURE COMBINATION USE -	6
INSTRUCTIONAL PROGRAM AND MODEL LESSONS -	7
FUNDAMENTAL TRAMPOLINE SKILLS -	8
ASSEMBLY INSTRUCTIONS -	10
FRAME ASSEMBLY -	11
ENCLOSURE POST ASSEMBLY -	14
MAT AND ENCLOSURE ASSEMBLY -	15
SAFETY PAD ASSEMBLY -	19
WARNING LABEL PLACEMENT -	21
ANCHOR KIT INSTALLATION -	22
MOVING THE TRAMPOLINE -	23
DISASSEMBLY -	23
CARE AND MAINTENANCE -	23
TRAMPOLINE PARTS LIST -	25
ENCLOSURE PARTS LIST -	26
ORDERING REPLACEMENT PARTS -	27
AVAILABLE ACCESSORIES -	28
MY TRAMPOLINE INFORMATION -	30
LIMITED WARRANTY -	31
WARRANTY REGISTRATION -	32
WARNINGS -	1, 2, 4, 5, 10, 21, & 22

# BEFORE YOU BEGIN

Thank you for purchasing a Propel Trampoline and enclosure net combination.

This trampoline and enclosure net combination comes equipped with warnings and instructions for its proper assembly, care, maintenance, and use. This information must be read by all supervisors and users before any person is allowed to use it.

Follow all warning pictures shown below or otherwise included elsewhere in this manual. If you have any questions regarding these warnings, please contact us.

After reading this manual, if you have further questions, or if you would like to contact us, please visit our web site at [www.PropelTrampolines.com](http://www.PropelTrampolines.com).

## Warning

1. DO NOT attempt or allow somersaults. Landing on the head or neck can cause serious injury, paralysis, or death, even when landing in the middle of the jumping mat.
2. Do not allow more than one person on the trampoline or inside the trampoline enclosure netted area. Use by more than one person at the same time can result in serious injury.
3. Use trampoline and trampoline enclosure only with mature, knowledgeable supervision.

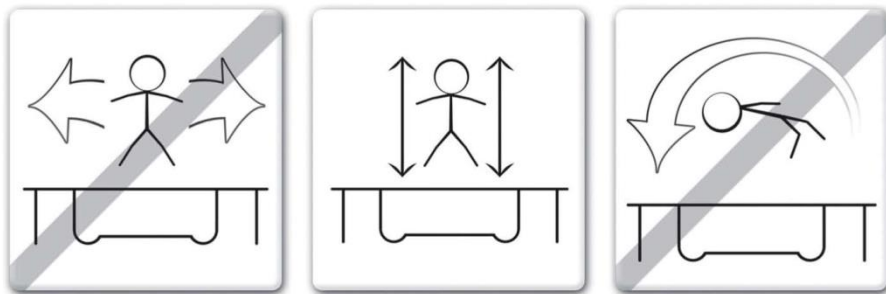

# INSTRUCTIONAL MATERIAL AND RULES FOR USE

## **Warning**

1. DO NOT attempt or allow somersaults. Landing on the head or neck can cause serious injury, paralysis, or death, even when landing in the middle of the jumping mat.
2. Do not allow more than one person on the trampoline. Use by more than one person at the same time can result in serious injuries.
3. Use trampoline only with mature, knowledgeable supervision.
4. Trampolines over 20 in. (51 cm) tall are not recommended for use by children under 6 years of age.
5. Inspect the trampoline and trampoline enclosure before each use. Make sure the barrier and the enclosure support (frame) and frame padding is correctly and securely positioned. Replace any worn, defective, or missing parts.
6. Users may become entangled in or strangled by loose cords or in gaps between trampoline and enclosure.
7. Keep enclosure tightly fastened to the trampoline in accordance with the manufacturer's instructions. Failure to properly assemble and maintain a tight, secure trampoline and enclosure net boundary may result in serious injury, strangulation, or death.
8. Do not attempt to jump over the barrier.
9. Do not attempt to crawl under the barrier.
10. Do not intentionally rebound off the barrier.
11. Do not hang from, kick, cut, or climb on the barrier.
12. Wear clothing free of drawstrings, hooks, loops, or anything that could get caught while using the trampoline and enclosure net combination. Failure to do so could result in entanglement, strangulation, or both.
13. Do not attach anything to the trampoline or trampoline enclosure net system that is not a manufacturer approved accessory.
14. Enter and exit the enclosure net only at the enclosure door opening, designated for that purpose.
15. Climb on and off the trampoline carefully. It is a dangerous practice to jump from the trampoline to the floor or ground when dismounting, or to jump

onto the trampoline when mounting. Do not use the trampoline as a springboard to other objects.

16. Stop bounce by flexing knees as feet come in contact with the trampoline bed. Learn this skill before attempting others.

17. Learn fundamental bouncing and body positions thoroughly before trying more advanced skills. A variety of trampoline activities can be carried out by performing the basic fundamentals in various series and combinations.

18. Avoid bouncing too high. Stay low until bounce control and repeated landing in the center of the trampoline can be accomplished. Control is more important than height.

19. While keeping the head erect, focus eyes on the trampoline toward the perimeter. This will help control bounce.

20. Avoid bouncing when tired. Keep turns short.

21. Properly secure the trampoline when not in use. Protect it against unauthorized use. If a trampoline ladder is used, the supervisor should remove it from the trampoline when leaving the area to prevent unsupervised access by children under 6 years of age.

22. Keep objects away which could interfere with the performer. Maintain a clear area around the trampoline.

23. Do not use the trampoline while under the influence of alcohol or drugs.

24. For additional information concerning the trampoline equipment, contact the manufacturer.

25. For information concerning skill training, contact a certified trampoline instructor.

26. Bounce only when the surface of the jumping mat is dry. Wind or air movement should be calm to gentle. The trampoline must not be used in gusty or severe winds.

27. Read all instructions before using the trampoline and trampoline enclosure net. Warnings and instructions for the care, maintenance, and use of this trampoline and trampoline enclosure net are included to promote safe and enjoyable use of this equipment.

## OVERVIEW OF TRAMPOLINE AND ENCLOSURE COMBINATION USE

The first practice sessions of your new trampoline and enclosure net combination should focus on learning fundamental body positions and practicing the eight basic jumps (see pages 8-9).

During this learning period jumpers should practice these basic techniques and perfect them. Braking, or checking the jump should be taught first and stressed as a safety measure. Jumpers should be able to break their jump whenever they start to lose their balance or control. Do this by flexing the knees sharply upon landing and absorbing the upward thrust of the jumping mat. This allows the jumper to stop suddenly and avoid losing control.

With any trampoline use the takeoff and landing points of a good, controlled jump are at the same place. A skill is considered learned only when a jumper is able to perform it correctly time after time. Jumpers should never go on to more advanced jumps until they can perform all eight basic jumps correctly each time.

**User should read and understand rules. Supervisor should be sure that these rules are always properly followed:**

1. Appropriate clothing should be worn, and could consist of a t-shirt and shorts. However, beginning jumpers may wish to wear loose-fitting protective clothing such as a long-sleeved shirt and long pants until correct landing techniques are mastered. This will reduce the chance of mat (jumping surface) burns from improper landings on elbows and knees.
2. Jumpers should wear regulation gymnastic shoes, heavy socks, or they may jump barefooted. Street shoes or tennis shoes should not be worn when using the trampoline and enclosure net combination as they cause excessive wear on the trampoline mat. Additionally, street shoes will introduce foreign materials to the jumping surface, causing it to wear prematurely.
3. Jumpers should never practice alone and unsupervised.
4. Only one person should be inside the trampoline and enclosure net at a time.
5. Uncontrolled jumping should not be permitted under any circumstances. All skills should be learned at moderate jumping heights; control, rather than height, should be emphasized.
6. Due to the safety enclosure net, the only way to exit the trampoline is to climb through the door and off the trampoline. Use caution when exiting from the trampoline to the ground surface.

## INSTRUCTIONAL PROGRAM AND MODEL LESSONS

The following lessons are examples of an instructional program. They should follow a complete discussion and demonstration of body mechanics between the supervisor and the student(s). See pages 8 and 9 for descriptions of basic jumping skills.

### Lesson 1

1. Mounting and dismounting (entering and exiting the enclosure netting)—Demonstration and practice of proper techniques.
2. Fundamental jump—Demonstration and practice.
3. Braking (stopping the jump)—Demonstration and practice. Braking on command.
4. Hand and knee drop—Demonstration and practice, stressing four-point landing and alignment.

### Lesson 2

1. Review and practice all skills previously learned.
2. Knee drop—Half twist to the right, to the left, to the feet, and then to the knees.
3. Seat drop—Half twist to the feet. Seat drop, knee drop, hand and knee drop, repeat.

### Lesson 3

1. Review and practice all skills previously learned.
2. Front drop—To save time and avoid mat (jumping surface) burns, all students should be requested to assume the front drop position on the floor while the instructor checks for faults.
3. Suggested progression: from hand and knee jump, the body is extended for the landing in the front drop position, and the rebound is made to the feet.
4. Practice routine—Hand and knee drop, front drop, feet, seat drop, half twist to feet.

### Lesson 4

1. Review and practice all skills previously learned.
2. Back drop—Demonstration, emphasizing the forward thrust of the hips by arching the body as one leg is brought forward from the standing (not jumping) position, and the drop to the back with the chin held forward to the chest and eyes forward on the frame pad. Supervising this skill is most important. Demonstration of back drop with low jump and practice of both techniques.

### Lesson 5

1. Review and practice all skills previously learned, encouraging original routines based on them.
2. Half turntable—Start from the front drop position and push to the left or right with the hands. Turn the head and shoulders in the same direction. Keep the back parallel to the jumping mat and the head up. After completing a half turn, land in the front drop position.

### Lesson 6

1. Review and practice all skills previously learned.
2. Swivel hips—Suggested progression: seat drop, feet, half twist, repeat; seat drop, half twist to feet, repeat; seat drop, half twist to seat drop.
3. Half turntable

# FUNDAMENTAL TRAMPOLINE SKILLS

## Fundamental Jump

1. Start from a standing position with your head erect and your eyes on the frame pad.
2. Swing your arms forward and up in a circular motion.
3. Bring your feet together and point your toes downward while in the air.
4. Keep your feet about shoulder width apart when landing on the mat.

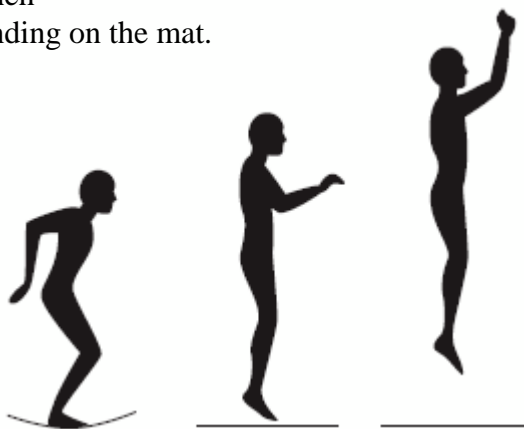

## Knee Drop

1. Start bouncing from a standing position, keeping your eyes on the frame pad.
2. Land on your knees, keeping your back straight and your body erect.
3. Come back up to an erect position.



## Hand and Knee Drop

1. Start bouncing from a standing position, keeping your eyes on the frame pad.
2. Land on the mat on your hands and knees.
3. Push with your hands and come back up to an erect position.

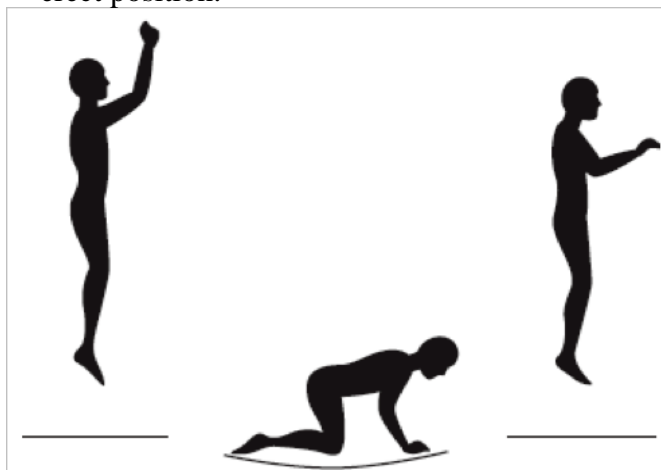

## Back Drop

1. Start from a low bounce and land on your back.
2. Keep your chin forward on your chest as you land.
3. Kick forward and up with your legs to return to an erect position.



## Seat Drop

1. Land in a sitting position with your legs parallel



to the mat.

2. Place your hands on the mat beside your hips.
3. Push with your hands to return to an erect position.

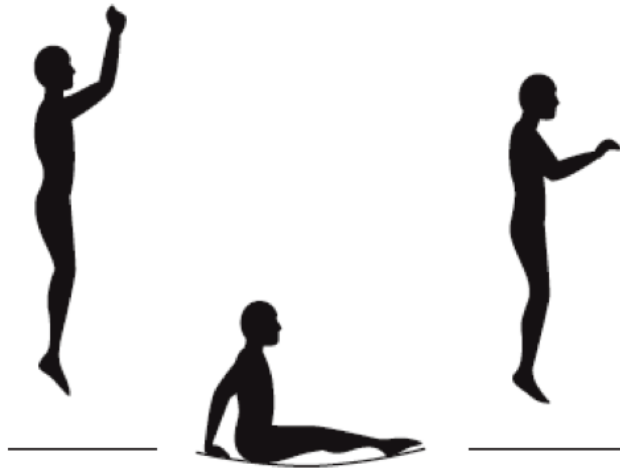

### Front Drop

1. Start from a low bounce and land on the mat in a prone position.
2. Keep your head up and your arms extended forward on the mat.
3. Push with your arms to return to an erect position.

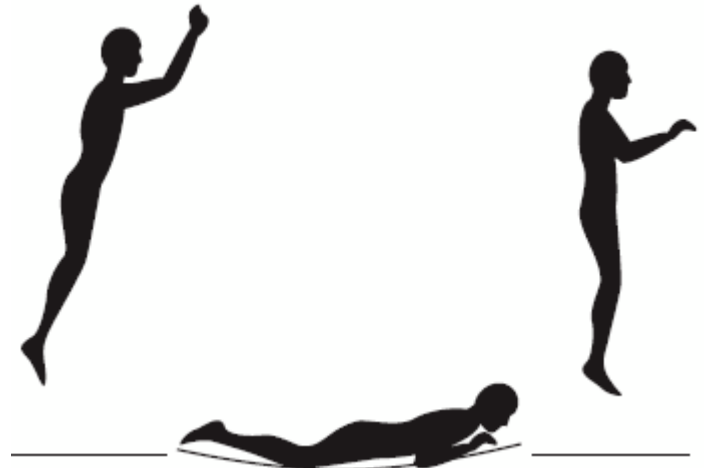

### Half Turntable

1. Start from the front drop position and push to the left or right with your arms to begin turning your body in the opposite direction.
2. Turn your head and shoulders toward the direction that your body is turning.
4. Keep your back parallel to the mat and your head up.
5. After completing a half turn, land in the front drop position.



### Swivel Hips

1. Start with a seat drop.
2. Turn your head to the left or right and swing your arms up in the same direction.
3. Turn your hips in the same direction as your head and arms, completing a twist.
4. Land in the seat drop position.



# ASSEMBLY INSTRUCTIONS

## **WARNINGS**

- Adequate overhead clearance is essential. A minimum of 24 feet from ground level is recommended. Provide clearance for wires, tree limbs, and other possible hazards.
- Lateral clearance is essential. Place the trampoline and trampoline enclosure net away from walls, structures, fences, and other play areas. Maintain a clear space on all sides of the trampoline and trampoline enclosure net.
- Place the trampoline and trampoline enclosure net on a level surface before use.
- Use the trampoline and trampoline enclosure net in a well-lit area. Artificial illumination may be required for indoor or shady areas.
- Secure the trampoline and trampoline enclosure net against unauthorized and unsupervised use.
- Remove any obstructions from beneath the trampoline and trampoline enclosure net.
- The trampoline enclosure net is only to be used as a safety enclosure net for a trampoline of the size for which the enclosure net is designed.
- The owner and supervisors of the trampoline and trampoline enclosure net are responsible to make all users are aware of practices specified in the user manual.
- The trampoline and enclosure net combination should not be installed or used on concrete, asphalt, or other similarly hard surfaces. Using your trampoline and enclosure net combination in such locations can increase the likelihood of injury when entering or exiting your trampoline.

## **IMPORTANT ASSEMBLY INFORMATION**

- You will need a Phillips Screwdriver (not included), and an adjustable wrench (not included) to assemble this trampoline and enclosure net combination.
- Assembly requires two adults.
- Wear gloves to protect your hands from pinch points during assembly.
- To extend the life of your product, a thin film of oil has been applied to all metal parts. Therefore, you should wear clothing and gloves during assembly which will not be damaged or stained by any slight oil residue. When the trampoline is completely assembled, all metal parts with oil film will be covered.

# Frame Assembly

*Read and understand all assembly instructions before beginning the assembly process.*

Your trampoline frame is assembled using two types of t-brackets; type A (regular t-brackets) and type B (enclosure t-brackets). The enclosure t-bracket includes a special slot to insert an enclosure pole. Each t-bracket has been pre-attached to a frame piece.

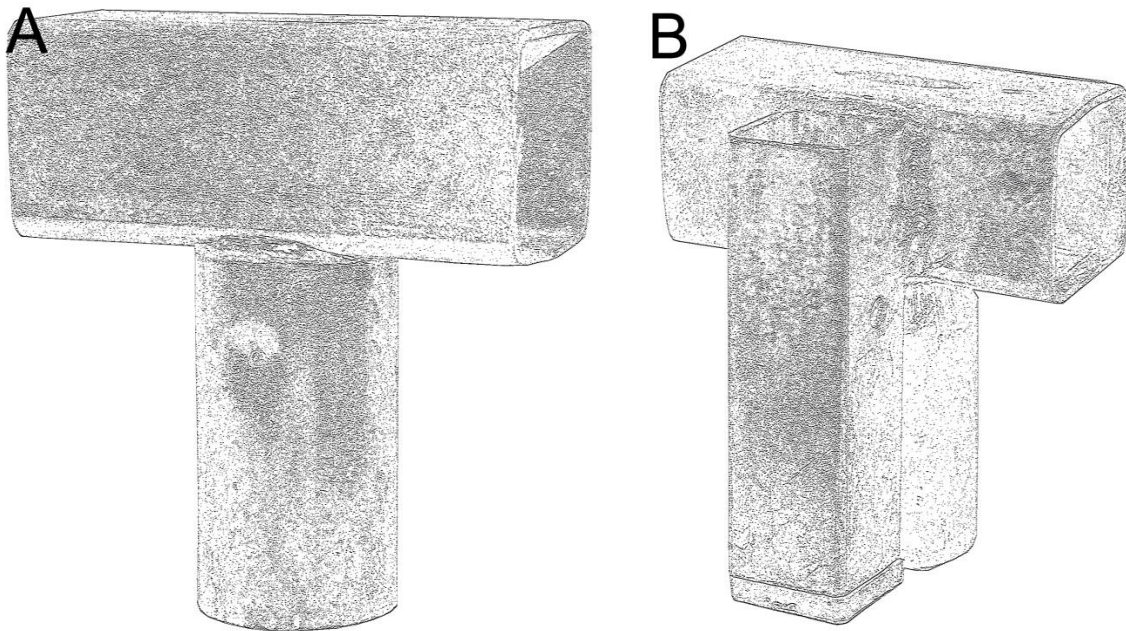

**Step 1-** Select one frame piece with a type A t-bracket and another with a type B t-bracket. Insert the crimped end of the frame piece with the type A t-bracket into the opening of the type t-bracket and place on ground with the spring holes facing down.

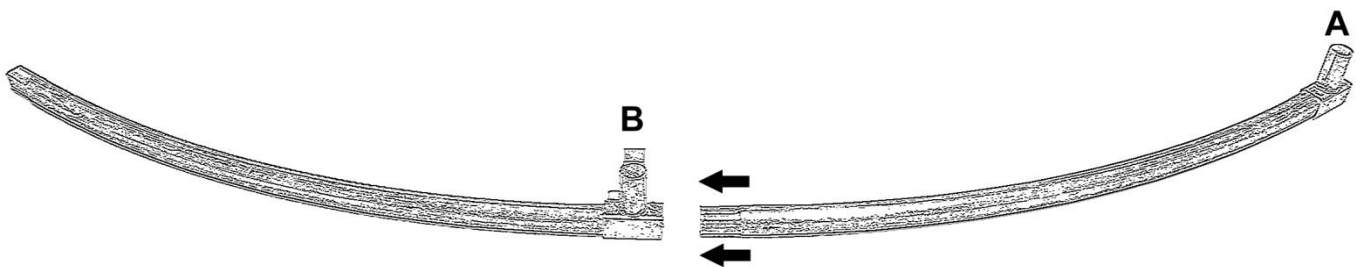

**Note:** Make sure the crimped end of the frame piece passes completely through the t-bracket and into the end of the adjoining frame piece.

**Step 2 -** Slide two leg tubes (C) onto a leg brace (D). One leg of each pair should have a

safety sticker attached. The peak of the brace (D) should point toward the ground.

Insert one of the leg tubes (C) into one of the t-brackets (which were previously assembled in step one). Insert the other leg into the other t-bracket. Press down on both legs at the same time to ensure that they are fully inserted into the sockets.

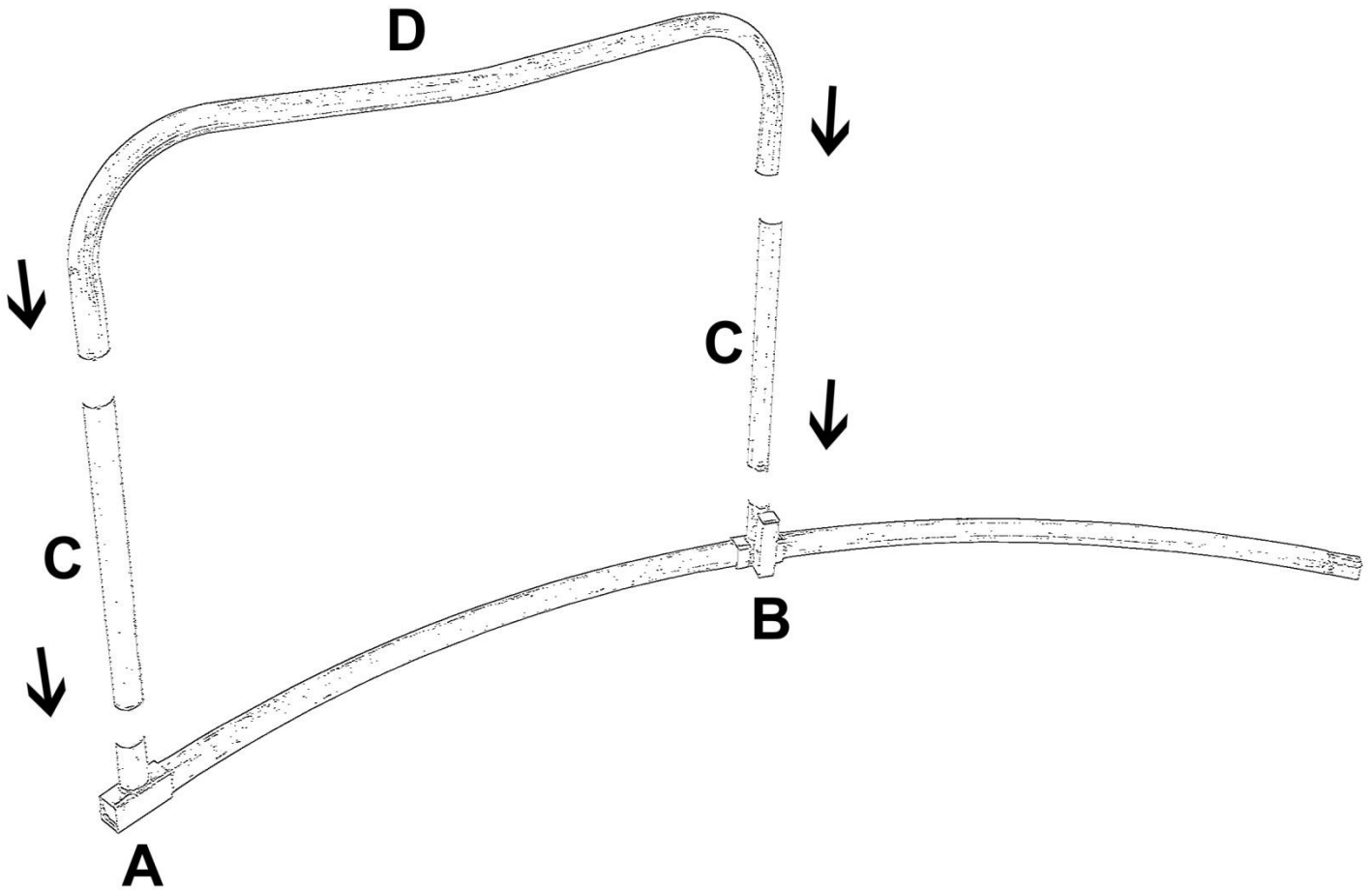

Repeat steps 1 and 2 until all of the legs are assembled for your trampoline.

Note: You may need to pull outward on the legs (C) as you insert them into the sockets. This is designed to keep your trampoline tightly assembled.

**Step 3** – Rotate two leg sections so the spring holes are facing up and hold them in the

positions shown in the figure below.

Insert the crimped end of the frame tube of one section into the t-bracket (A) of another.

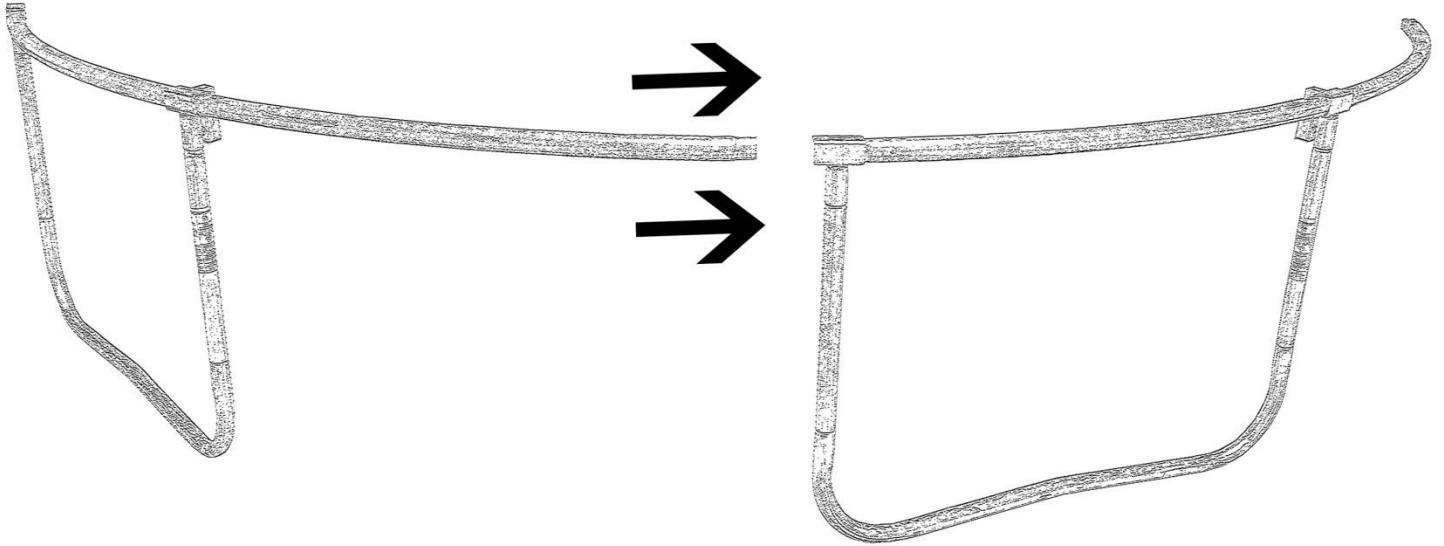

Repeat this step; inserting each leg section into the next to complete the trampoline frame circle.

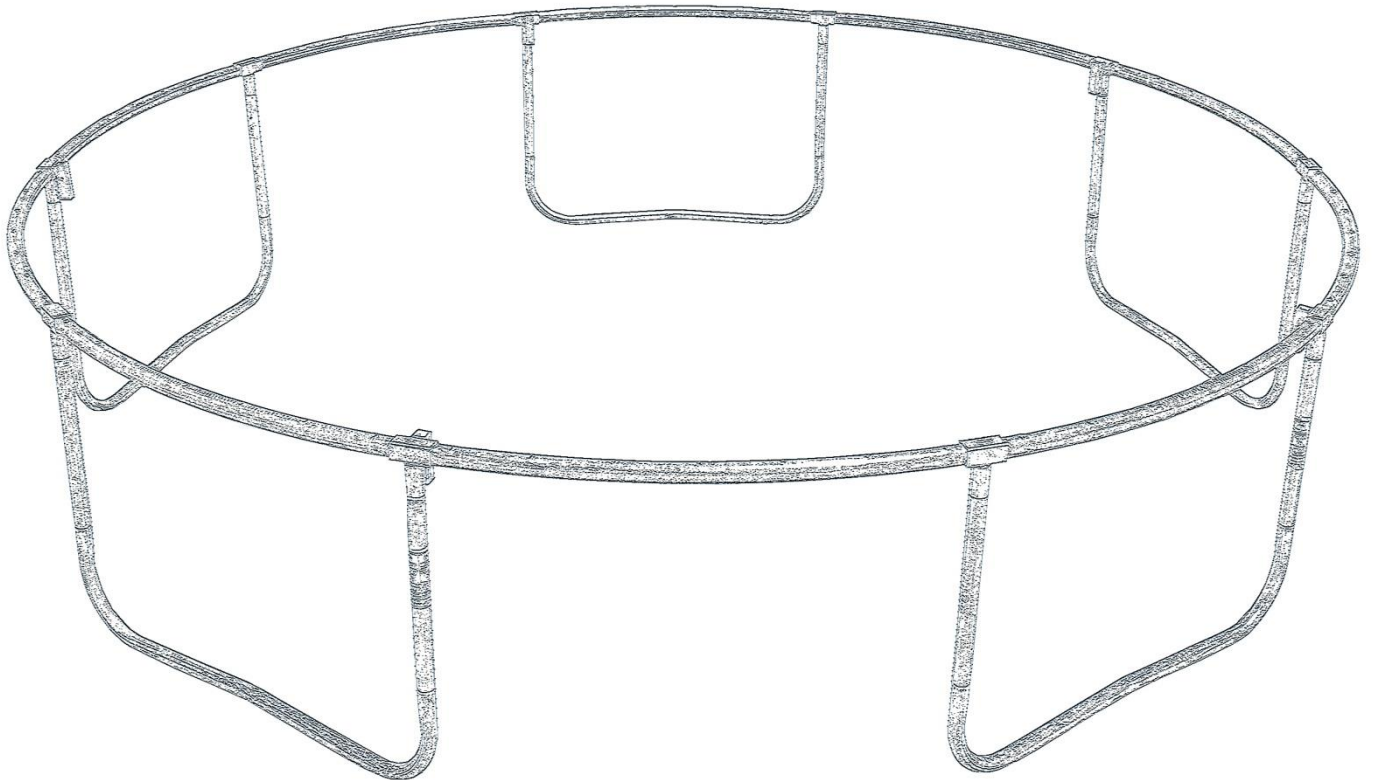

## Enclosure Pole Assembly

*Read and understand all assembly instructions before beginning the assembly process.*

Your trampoline's enclosure poles come in two sections; an upper (curved) and a lower (straight) section.

**Step 1** – Connect one upper pole section and one lower pole section together, making sure to match the screw holes in the two sections. See the figure to the right.

**Step 2** – Secure the poles with a screw in the center hole and slide the foam sleeves together to cover the screw.



**Caution: Do not over-tighten the screws or the hole will be stripped out.**



Repeat steps 1 and 2 until you have assembled all of the enclosure poles; then set them aside for use in later steps.

## Jumping Mat and Enclosure Net

# Assembly

*Read and understand all assembly instructions before beginning the assembly process.*

*This trampoline should not be installed without the included enclosure safety net.*

**Step 1** – Unfold and lay the jumping mat (jumping surface) on the ground inside the trampoline frame circle. Make sure the warning labels are facing up.

**Step 2** – Hook the jumping mat to the frame by attaching one spring to the right of each t-bracket (see illustration below). To attach a spring, hook the short end to a v-ring sewn to the jumping mat and pull the spring back towards the frame using the included spring puller. Insert the long end of the spring into a slot in the frame and then release the spring. You will need to count the number of slots between t-brackets so that you can find the corresponding v-ring on the jumping mat to attach the next spring.

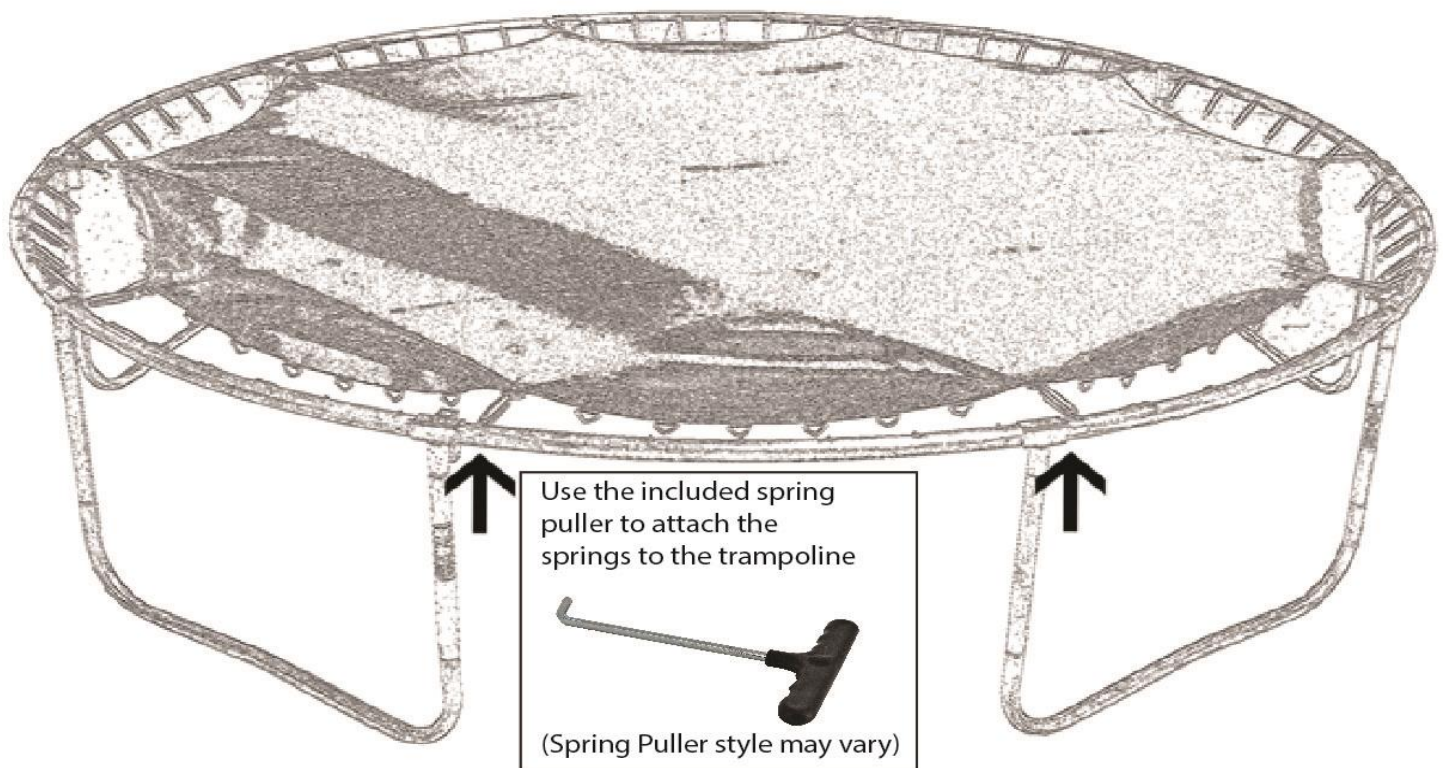

**Caution: Be careful where you place your hands as the spring and frame joints can pinch. We recommend wearing leather gloves while attaching the springs.**

**Note: DO NOT attach all of the springs in this step. Only attach the springs to the right of each t-bracket**

**Step 3** – Unfold the enclosure netting. Locate the zipper opening and ensure that the warning labels are facing outwards.

**Step 4** – Locate the Bungee Straps sewn to the top edge of the Enclosure and connect all Bungee Loops with Bolts to your Enclosure Net by inserting the Bolt up through the Net Loop and bringing it down through the resulting Loop in the Bungee Cord, as shown in the illustrations below.

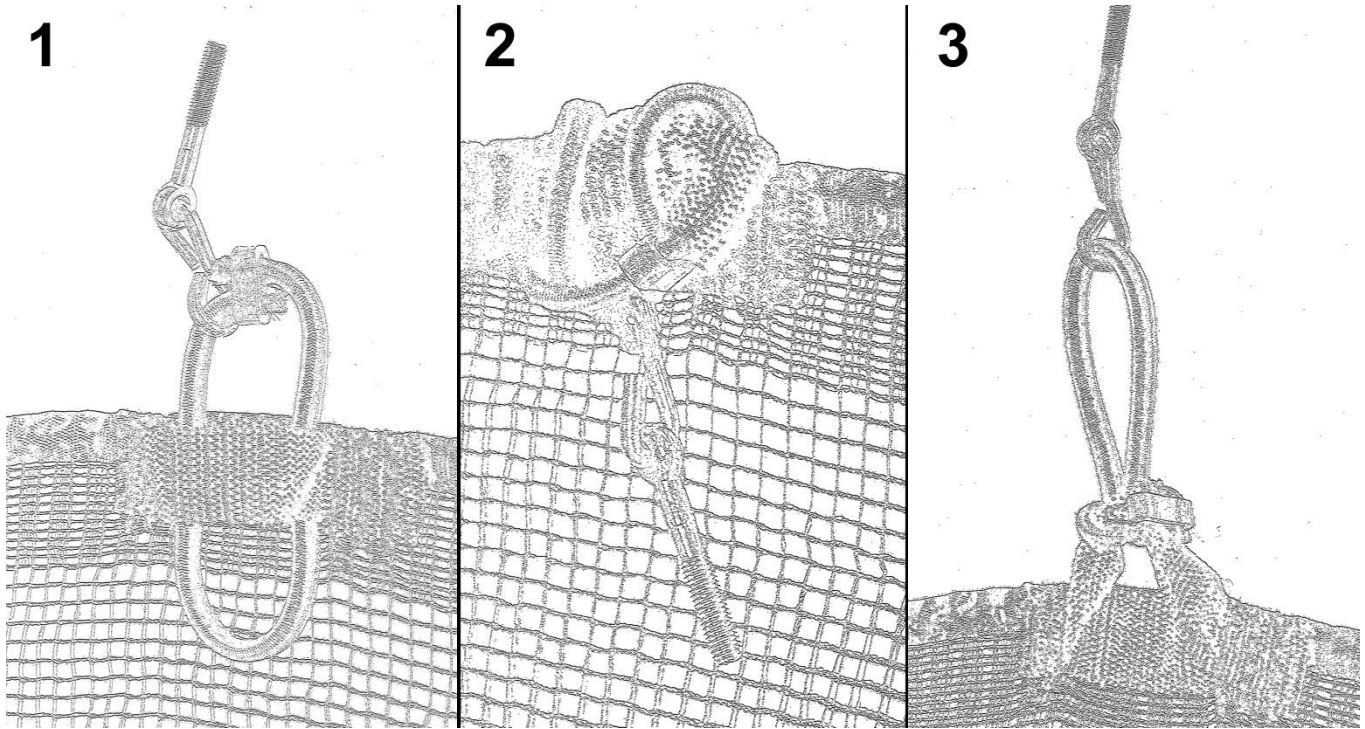

**Step 5** – Insert the Bungee Cord Bolt through the Hole near the top of the Enclosure Post and secure it with the corresponding Nut. Adequately tighten the Nut with a Wrench. Repeat this procedure for each remaining Enclosure Post.



**Step 6** – Stand each Post upright with the Curved Section facing outward. Insert the bottom end of the Post into its corresponding T-Bracket Slot. This eliminates the need for a stepladder, allowing the Enclosure to be completely erected from ground level. Repeat this process for the remaining Upright Posts.

**DO NOT** Bolt the Enclosure Posts in place as part of this step. This will be completed later, as the last step in assembling your Trampoline.





**Step 7** – Your enclosure net should now be hanging loosely from the enclosure poles with the zippered opening centered between two enclosure poles. Straighten out any areas where the enclosure netting appears to be bunched up.

**Step 8** – Now starting on the left side of the t-bracket feed the short end of a new spring through the enclosure net near the bottom edge and attach it to the v-ring (as shown in figure 1 below). Now pull the spring back towards the frame using the included spring puller and insert the long end into the corresponding slot of the frame. You should now have a spring on each side of the t-bracket. One on the left attached to the enclosure net and jumping mat, and the other on the right attached to the jumping mat (as shown in figure 2).

Figure 1



Figure 2



One spring attached through the enclosure netting and the other spring still attached directly to the jumping mat.

Repeat this process by working your way around the trampoline attaching one spring to the left of each t-bracket.

As you work around the trampoline ensure that the enclosure netting is evenly stretched and that there is no bunching of the net in between springs.

**Step 9** – You should now have one spring connected on both sides of each t-bracket (as shown in the picture below).



Now remove the spring on the right side of each t-bracket and re-attach it through the enclosure netting to the corresponding v-ring on the jumping mat. Note, that from this point on when attaching springs they must be attached to the jumping mat through the enclosure net. This is an important safety feature as the springs hold the enclosure net close to the jumping mat.

**Step 10** – In this step you will attach the remaining springs. It is important that the springs are attached in a manner that maintains a tension balance around the trampoline frame. Note, that the t-brackets and the springs you have already attached divide the frame into several sections. Beginning in one section attach one spring to the right of an existing spring attaching it in the same manner as instructed before in step 8; then move to the next section and attach another spring to the right of that existing spring. Repeat this process until all springs have been attached. Attaching the springs one spring per section as directed will prevent damage caused by overstretching during assembly. This will also make it easier to attach the remaining springs.

# Safety Pad Assembly

*Read and understand all assembly instructions before beginning the assembly process.*



**Step 1** – Lift the enclosure poles out of the t-bracket slots and lean them forward so they are resting on the jumping mat (as shown in the picture to the left).

**Step 2** – Unfold the safety pad so it is resting on the frame and springs.

**Step 3** – Rotate the pad so that the logo sits approximately in front of the zipper and the holes in the pad align with the enclosure pole slots on the t-brackets.

Note: Securely attaching and positioning the frame padding is essential to the safety of your trampoline. Check to ensure the frame pad is correctly positioned before each use. The frame pad should be positioned so that it covers the entire spring and frame area (as shown in the figure to the right).

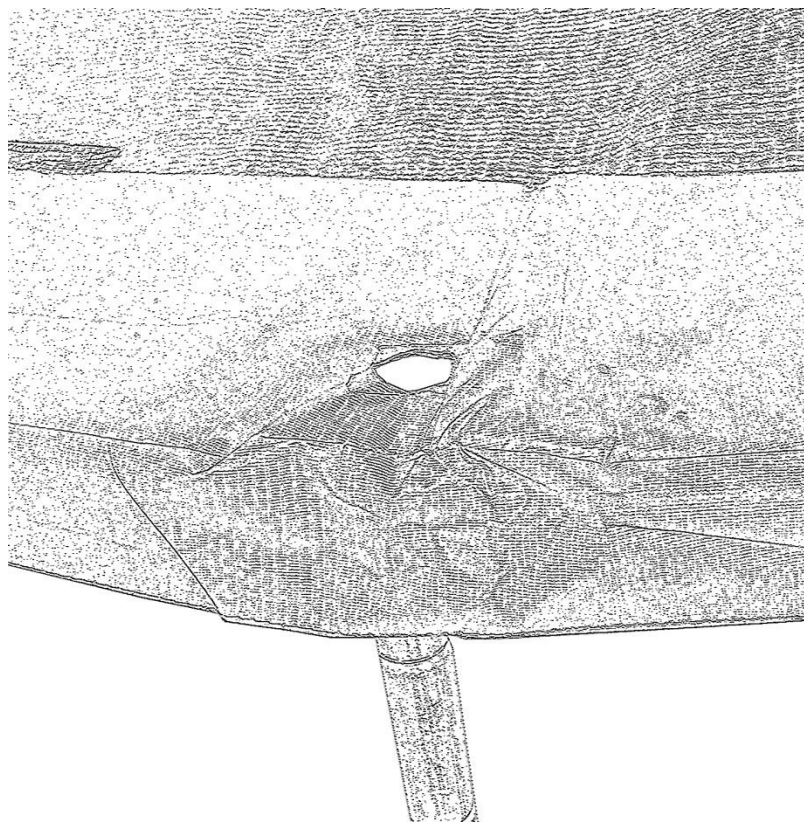

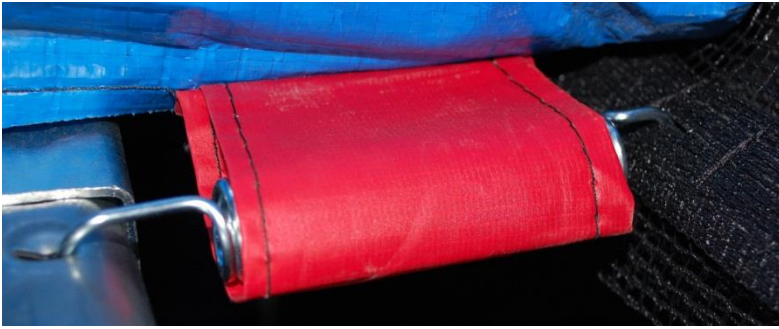

**Step 4** –Locate the spring loops on the underside of the pad. Find the spring nearest to the spring loop and unhook it from the frame. Insert the spring through the spring loop, and reattach it to the frame. Repeat this step until all spring loops have been attached.

**Step 5** – Lift the enclosure poles and insert them through the hole in the pad and into the t-bracket slot.

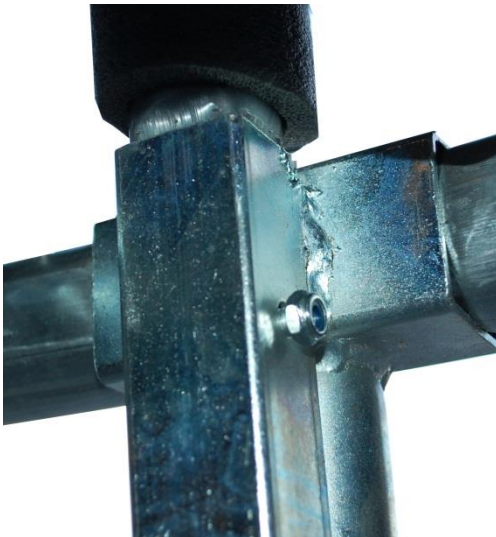

**Step 6** – Secure the Enclosure Poles to the Frame by attaching the included Bolts through the T-Brackets.

NOTE: Foam sleeves covering the enclosure poles may require a few warm days to fully return to their original round shapes after being flattened during the shipping process. Similarly, any folds or creases in the spring pad, jumping mat, or enclosure net should disappear within a short time.



Make sure that all parts are securely attached. Familiarize yourself and all users of the trampoline and trampoline enclosure net combination with all safety precautions. Use the instructions, care, and maintenance materials in this manual before using the trampoline.

# WARNING LABEL PLACEMENTS

Note: These labels are not shown at their actual size.

**WARNING**

**Trampoline Safety Instructions**



Do not land on head or neck. Do not attempt or allow somersaults. Landing on your head or neck can cause serious injury, paralysis, or death, even when landing in the middle of the mat. Use trampoline only with mature, knowledgeable supervision.



Only one person at a time on the trampoline. Do not allow more than one person on the trampoline. Use by more than one person at the same time increases the chance of injury. Use trampoline only with mature, knowledgeable supervision. This trampoline is not recommended for children under 6 years of age.

**For the Supervisor**  
Read the instructions before using the trampoline. Enclose all of the safety rules and be familiar with the information in the User's Manual to help new users learn basic jumps and all users to follow trampoline safety.

All trampoline users must have mature, knowledgeable supervision, regardless of the skill or age of the jumper.

This trampoline is not recommended for use by children under 6 years of age.

Inspect the trampoline before using. Keep frame pad in place. A worn or damaged mat (bed), spring, or frame piece should be replaced immediately.

Keep objects away that could interfere with the jumper.

Secure the trampoline against an unobstructed and unopened side.

Do not use when trampoline is wet or in a windy condition.

**For the Jumper**  
Do not use the trampoline when under the influence of drugs or alcohol.

Avoid bouncing when tired.

**Jumping**  
Use in the basic jumps and body position very well before trying more difficult stunts. Study the User's Manual to learn how to do basic jumps.

Stop your bounce by flexing your knees as your feet come in contact with the trampoline mat (bed).

Avoid jumping too high or for too long. Always control your jump. A controlled jump is one where the take off and land spots are the same.

Source is the center of the trampoline. Focus eyes on trampoline toward the perimeter mat. Failure to do so may result in a loss of balance and control.

Take time jumping one at a time, and always have someone watch you.

**Getting on and off**  
Climb on to and off of the trampoline. Do not jump on or off. Do not use the trampoline as a springboard in other objects.

For further equipment information contact PopUp. For skill training information, contact a trainer/certification organization.

**ATTACH TO TRAMPOLINE**

1313

**WARNING/ADVERTENCIA**



Do not land on head or neck. Do not attempt or allow somersaults. Landing on your head or neck can cause serious injury, paralysis, or death, even when landing in the middle of the mat. Use trampoline only with mature, knowledgeable supervision.



Only one person at a time on the trampoline. Do not allow more than one person on the trampoline. Use by more than one person at the same time increases the chance of injury. Use trampoline only with mature, knowledgeable supervision. This trampoline is not recommended for children under 6 years of age.

**Advertencia**  
Solo permiten una persona a la vez en la trampolina. No se permite mas que una persona al mismo tiempo aumente el riesgo de daño. Use la trampolina solamente con vigilancia madura y adecuada. Esta trampolina no es recomendada por niños que tienen menos de seis años.

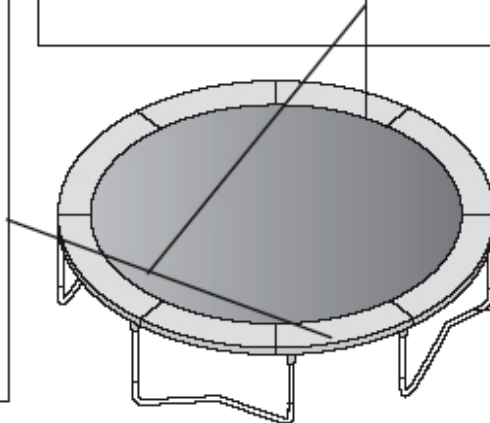

**WARNING**



Do not land on head or neck. Landing on your head or neck can cause serious injury, paralysis, or death, even when landing in the middle of the mat. Use trampoline only with mature, knowledgeable supervision.



Do not allow more than one person on the trampoline.

Multiple jumpers increase the chance of loss of control, collision and falling off. This can result in broken head, neck, back or legs.

Use trampoline only with mature, knowledgeable supervision.

This trampoline is not recommended for children under 6 years of age.

Read all of the instructions before using this trampoline.

Inspect before using and replace any worn, defective or missing parts.

1312

**WARNING**

**Enclosure Net Instructions**



Do not land on head or neck. Do not attempt or allow somersaults. Landing on your head or neck can cause serious injury, paralysis, or death, even when landing in the middle of the mat. Use trampoline only with mature, knowledgeable supervision.



Only one person at a time on the trampoline. Do not allow more than one person on the trampoline. Use by more than one person at the same time increases the chance of injury. Use trampoline only with mature, knowledgeable supervision. This trampoline is not recommended for children under 6 years of age.

**Enclosure Instructions**  
Read the instructions before using the trampoline. Enclose all of the safety rules and be familiar with the information in the User's Manual to help new users learn basic jumps and all users to follow trampoline safety.

All trampoline users must have mature, knowledgeable supervision, regardless of the skill or age of the jumper.

This trampoline is not recommended for use by children under 6 years of age.

Inspect the trampoline before using. Keep frame pad in place. A worn or damaged mat (bed), spring, or frame piece should be replaced immediately.

Keep objects away that could interfere with the jumper.

Secure the trampoline against an unobstructed and unopened side.

Do not use when trampoline is wet or in a windy condition.

**For the Jumper**  
Do not use the trampoline when under the influence of drugs or alcohol.

Avoid bouncing when tired.

**Jumping**  
Use in the basic jumps and body position very well before trying more difficult stunts. Study the User's Manual to learn how to do basic jumps.

Stop your bounce by flexing your knees as your feet come in contact with the trampoline mat (bed).

Avoid jumping too high or for too long. Always control your jump. A controlled jump is one where the take off and land spots are the same.

Source is the center of the trampoline. Focus eyes on trampoline toward the perimeter mat. Failure to do so may result in a loss of balance and control.

Take time jumping one at a time, and always have someone watch you.

**Getting on and off**  
Climb on to and off of the trampoline. Do not jump on or off. Do not use the trampoline as a springboard in other objects.

For further equipment information contact PopUp. For skill training information, contact a trainer/certification organization.

**ATTACH TO SETTING UP DOOR**

1314

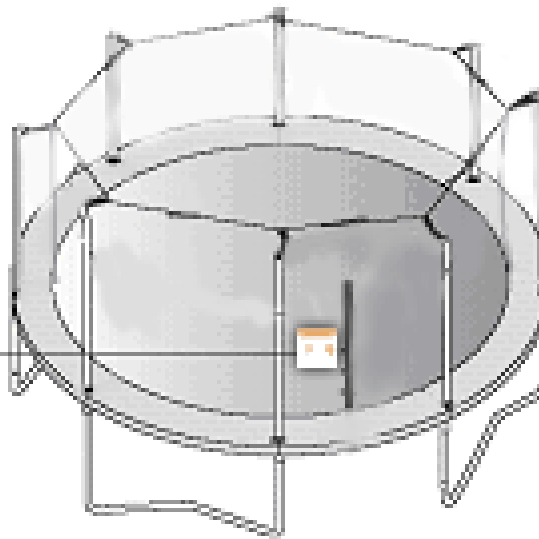

These labels have been attached to the Trampoline Enclosure in the indicated locations. Please verify that none of these labels are missing or illegible. If so, please contact us and request a free replacement.

***Your trampoline and enclosure net combination is now fully assembled.***

# StormRider Trampoline Anchor Kit

Trampolines, especially those with enclosure nets can be blown and severely damaged by wind. It is highly recommended that you secure your trampoline against the wind. Some trampoline models include one of our StormRider Anchor Kits; if so, please follow the instructions on this page to install it correctly. More information about this anchor kit and a selection of other accessories may be found on page 28. Anchor kits may also be purchased online at [www.PropelTrampolines.com](http://www.PropelTrampolines.com).

**Step 1-** Evenly space the stakes around the perimeter of your trampoline.

**Step 2-** Using a rubber mallet, pound each stake at a 45 degree angle into the ground until it is flush with ground level.

**Step 3-** Secure the straps to the frame of the trampoline by looping the strap over the frame and following back through the ladder locks. Then take the strap and loop it through the lower ladder lock. See illustrations below.

**NOTE:** To ensure the effectiveness of your anchor kit, keep Straps tight at all times.

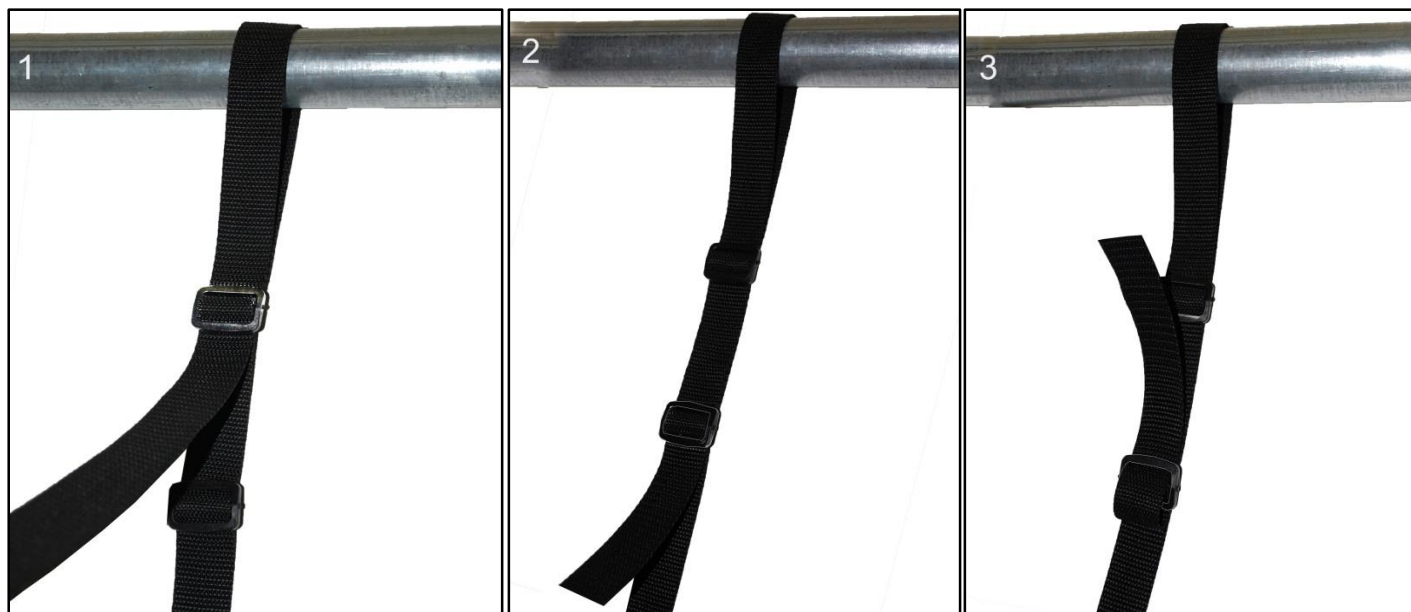

This completes the installation of your StormRider Anchor Kit.

**Warning:** The installation and use of an anchor kit does not guarantee that your trampoline will not be damaged by wind or other severe weather. Many factors such as soil types influence the effectiveness of this product. If using this product in sandy, loose soil, or in a high wind area it is recommended that you purchase and use two anchor kits. You may have to take other precautions such as, disassembling your trampoline during times of severe weather. Using an anchor kit is not an insurance policy and will not add additional warranty benefits to your trampoline. Propel Trampolines and its retailers/affiliates will not be held responsible for damages to persons or property as a result of the failure of this product.

# **MOVING THE TRAMPOLINE AND ENCLOSURE NET COBINATION**

If the trampoline and enclosure net combination needs to be moved, it must be done by a minimum of two (preferably four) adults. Keep the trampoline horizontal and lifted slightly. If necessary, it can be taken apart for moving.

## **DISASSEMBLY**

To disassemble (take apart) the trampoline and enclosure net combination, follow the trampoline and enclosure net combination assembly steps in reverse order. Do not attempt to disassemble any trampoline frame parts before the springs and jumping mat have been completely removed. Use gloves to protect your hands from pinch points while taking the trampoline and enclosure net apart.

## **CARE AND MAINTENANCE**

### **CARE**

Do not allow pets on or within the trampoline. Their claws may damage the frame pad or snag the jumping mat and enclosure net material.

This trampoline and enclosure net combination is intended to be used by only one person at a time; weighing no more than 300 lbs. (15 foot), 275 lbs. (14 foot), 250 lbs. (12 foot), 225 lbs. (10 foot), or 200 lbs. (8-7 foot).

The user should be either barefoot, wearing socks, or wearing gymnastic shoes. Street shoes or tennis shoes should not be used with this trampoline.

The user should remove all objects from his/ her person that may cause injury or damage to the jumping mat or to themselves. Heavy sharp, or pointed hard objects should never touch the jumping mat or be allowed within or near the trampoline, or trampoline enclosure net.

Snow or ice should not be allowed to accumulate on the jumping mat or enclosure net. This can overstretch the springs and cause damage to the jumping mat and enclosure net.

## MAINTENANCE

Your trampoline and enclosure net combination was manufactured using the highest quality materials. It was crafted to provide you and your family with years of enjoyment and exercise. Proper maintenance and care will help to prolong the life of your trampoline and enclosure net combination. Proper maintenance will also reduce the possibility of injury. The following guidelines should always be followed:

1. If you live in a snowy region or experience long periods when your trampoline isn't being used you should remove your spring pad, jumping mat, and enclosure net. After removal you should properly store them in a dry area. This can add years to the life of these parts.
2. Inspect the trampoline and trampoline enclosure net before each use and replace any worn, defective, or missing parts. The following conditions could represent potential hazards:
  - (1) Missing parts, improperly positioned parts, insecurely attached barrier or enclosure support system, missing pole caps or damaged spring and frame padding.
  - (2) Punctures, frays, tears, or holes worn in the enclosure net, spring pad or jumping mat.
  - (3) Deterioration in the stitching or fabric of the bed or frame padding or in the barrier or support system (frame) padding,
  - (4) Ruptured springs,
  - (5) A bent or broken frame or enclosure support system (frame),
  - (6) A sagging barrier or bed, or
  - (7) Sharp protrusions on the frame or suspension system.

If any of these conditions exist, the Trampoline and Enclosure Combination should be taken apart, or otherwise protected against use, until the condition is repaired.



## TRAMPOLINE PARTS LIST

	15-Foot		14-Foot	12-Foot	10-Foot	8 Foot	7 Foot
	PTSA15-108	P15D-RE					
<b>1. Frame Tube</b>	12	12	12	12	8	8	8
<b>2. T-Bracket A</b>	6	6	6	6	4	4	4
<b>3. T-Bracket B</b>	6	6	6	6	4	4	4
<b>4. Leg Tube</b>	12	12	12	12	8	8	8
<b>5. Leg Brace</b>	6	6	6	6	4	4	4
<b>6. Jumping Mat</b>	1	1	1	1	1	1	1
<b>7. Pad</b>	1	1	1	1	1	1	1
<b>8. Springs</b>	108	96	72	72	56	48	40
<b>9. Warning Labels</b>	1 Set	1 Set	1 Set	1 Set	1 Set	1 Set	1 Set
<b>10. Anchor Kit</b>	1 kit	1 kit	Not Included	Not Included	Not Included	Not Included	Not Included

Specifications are subject to change without notice.

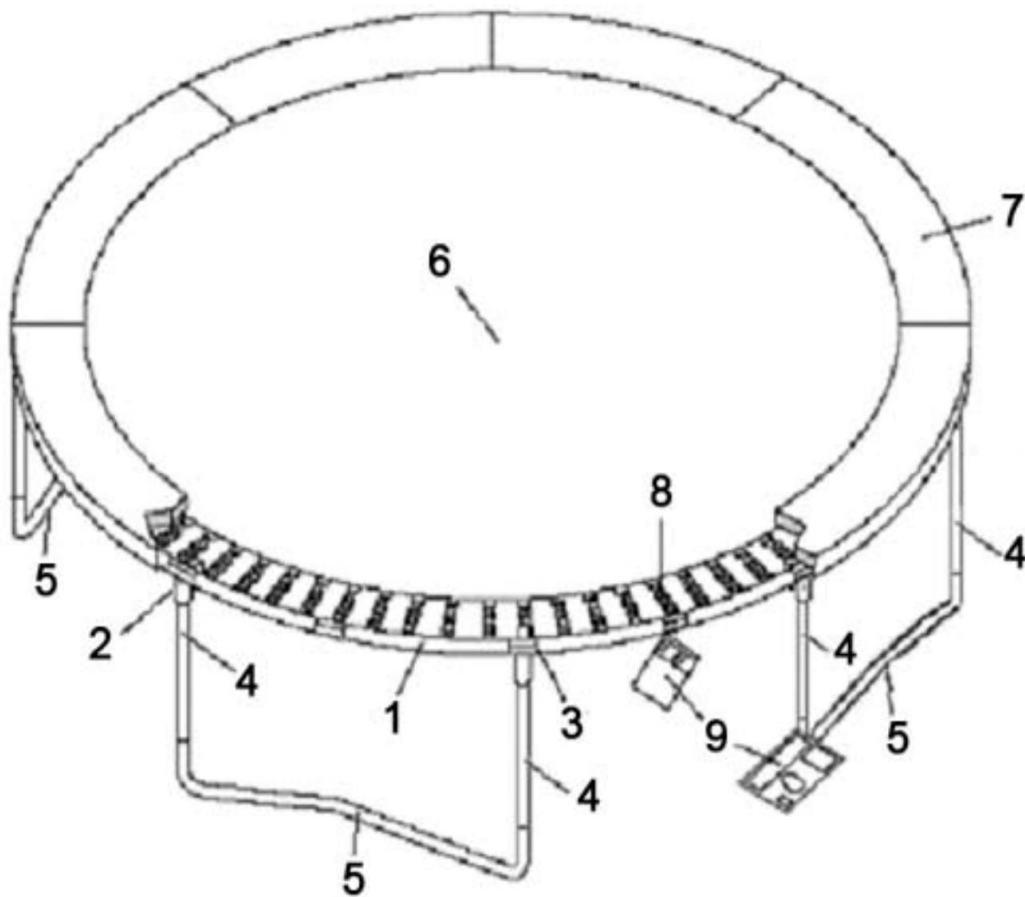

Diagram showing numbered parts.

## ENCLOSURE PARTS LIST

	15 -Foot	14-Foot	12-Foot	10-Foot	7,8-Foot
1. Enclosure Net	1	1	1	1	1
2. Foam Sleeves	12	12	12	8	8
3. Bungees w/ Bolts	6	6	6	4	4
4. Bungee Bolt Nuts	6	6	6	4	4
5. Post Screws	6	6	6	4	4
6. Frame Nuts & Bolts	6	6	6	4	4
7. Curved Post Section	6	6	6	4	4
8. Straight Post Section	6	6 </td <td>6</td> <td>4</td> <td>4</td>	6	4	4

Specifications are subject to change without notice.

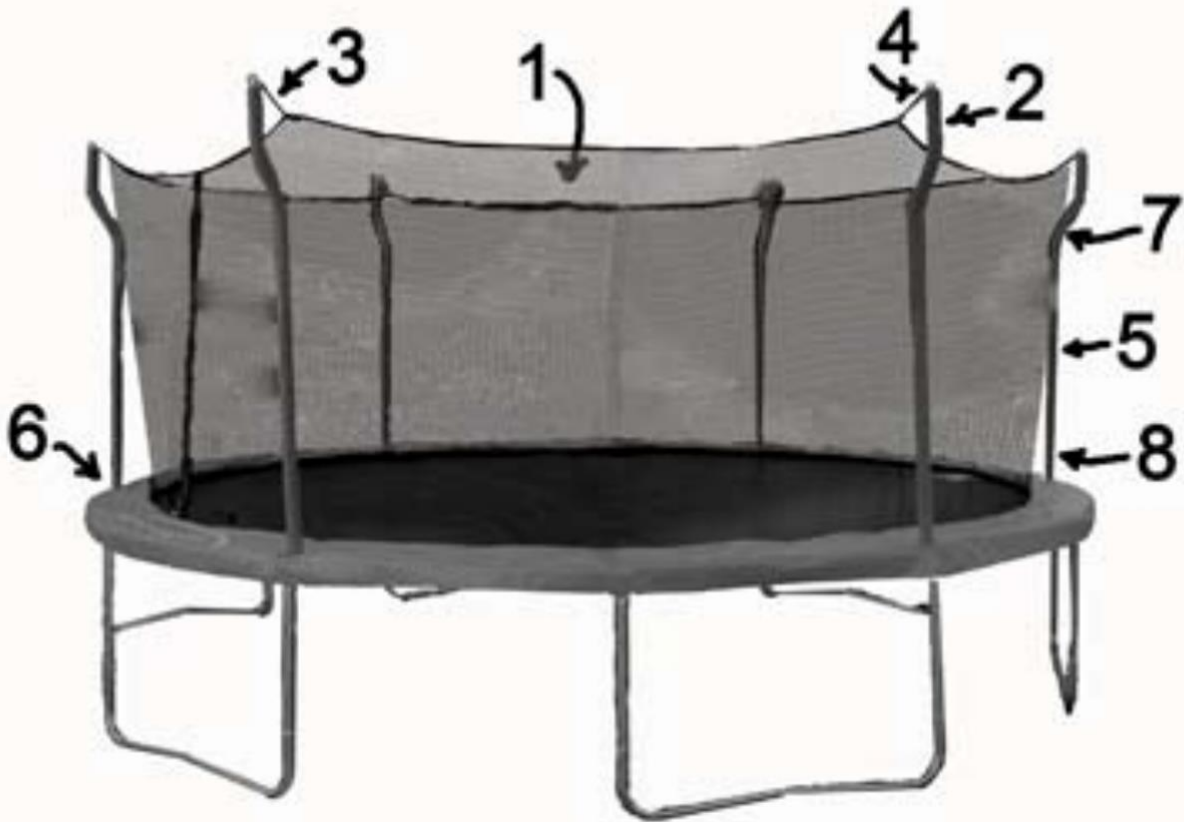

Diagram showing numbered parts.

## REPLACEMENT PARTS

To order replacement parts please visit our website at [www.PropelTrampolines.com](http://www.PropelTrampolines.com). Before visiting the website be sure you know the *model number* and the *number of springs* your trampoline has. If you need assistance ordering parts or have others questions about your trampoline please call the customer service number listed in the Information section of our website.

# AVAILABLE ACCESSORIES

## Anchor Kit-

Do you like to see your trampoline fly? Neither do we, that's why we carry the "StormRider" trampoline anchor kit. Our Stormrider Anchor kit includes three galvanized steel stakes which connect to your trampoline via high-strength straps. When used correctly, an Anchor Kit can help reduce the risk of costly wind damage to your trampoline.



## Weather Cover-

From the scorching summer heat to the freezing winter snow and rain the Propel Trampoline's Weather Cover can help protect your trampoline. Made from a weather resistant woven poly material it can be used in all 4 seasons; making it the perfect product to protect and help extend the life of your trampoline.



Note: Weather cover is not designed to support snow loads.

## Ladder-

The Propel Trampoline's Ladder provides a step-by-step method for accessing your trampoline. A trampoline ladder can help prevent injuries sustained by jumping on or off the trampoline.



Ladder

Note: Ladder should be detached from trampoline when unauthorized use of trampoline is not permitted. Ladder is not to be used by children under 6 years of age.

### **Spring Puller (Included with Trampoline) -**

Need an extra "hand" in assembling your trampoline? Use the included Spring Puller! This useful tool can help make attaching the springs a breeze. (Spring Puller style may vary).



### **Preschool Trampoline-**

The Propel Preschooler trampoline is a safe and fun trampoline for your little ones. The Preschooler trampoline includes a soft yet durable safety enclosure attached directly to the jumping mat, with thick padded poles to prevent your child from falling off. A base net prevents toys, children and pets from accessing under the jumper. Instead of hard metal springs, it incorporates 30 heavy duty bungees to provide a great bounce while eliminating the dangers of conventional springs. The healthy fun of the Propel Preschooler Trampoline can be used both indoors and outdoors so your children can jump anytime. Bring it along to the park, or into the play room when the weather turns sour. Wherever you are, the Propel Preschooler trampoline can be too!



**For more information or to order any of these accessories, please visit our website at [www.PropelTrampolines.com](http://www.PropelTrampolines.com).**

## MY TRAMPOLINE INFORMATION

In the event you need to contact customer service, such as to ask questions, order replacement parts, or file a warranty claim; you will be asked to provide some basic information about your trampoline. By writing this information in the spaces below and keeping this Manual in an accessible location, you can help expedite this process.

Staple or otherwise affix dated sales receipt here.

If it is necessary to file a warranty claim, you will be asked to provide a copy for proof of date of purchase.

— —

**The following information can be found printed on the end of the box in which your Trampoline came.**

Model or Item number: \_\_\_\_\_

MF Code: \_\_\_\_\_

Manufacturing Facility: \_\_\_\_\_

# LIMITED WARRANTY

PROPEL warrants its trampoline products to be free from defects in material and workmanship under normal use and service conditions. The galvanized steel trampoline frame and springs are warranted for one (1) year from the date of purchase. All other parts are warranted for ninety (90) days from the date of purchase.

All warranty coverage extends only to the original retail purchaser from the original date of purchase. Our obligation under this warranty is limited to replacing or repairing the product at our discretion. All products for which a warranty claim is made must be received by us at one of our authorized service centers. Freight must be prepaid and accompanied by proof of purchase. All returns must be pre-authorized. This Warranty does not extend to any product, or damage to a product that is caused by or attributable to freight damage, abuse, misuse, improper or abnormal usage, act of God, storm damage, installation or use of accessories, repairs not performed by our authorized service center, and to products used for commercial or rental purposes. No other warranty expressed or implied beyond that specifically set forth above is authorized.

Propel Trampolines is not responsible or liable for indirect, special, or consequential damages arising out of, or in connection with the use or performance of this product. Propel is not responsible for other damages with respect to any economic loss, loss of property, loss of revenue or profits, loss of enjoyment or use, cost of removal or installation, and any other consequential damages. In the United States of America some states do not allow the exclusion or limitation of incidental or consequential damages. Accordingly, the above limitation may not apply to you.

The warranty extended hereunder is in lieu of all other warranties, and any implied warranty of merchantability or fitness for a particular purpose is limited in its scope and duration to the terms set forth herein. In the United States of America some states do not allow limitations on how long an implied warranty lasts. Accordingly, the above limitation may not apply to you.

This warranty gives you specific legal rights. You may also have other rights which vary from state to state in the United States of America.

# Warranty Registration

Don't forget to register your trampoline by visiting [www.PropelTrampolines.com/warranty](http://www.PropelTrampolines.com/warranty).

Registering your trampoline entitles you to receive all warranty benefits.

You may also register your trampoline by mailing a copy of your sales receipt along with your name, address, phone number and the model number of your trampoline to:

Propel Trampolines  
Warranty Department  
41 East 400 North #324  
Logan, UT 84321

[www.propeltrampolines.com](http://www.propeltrampolines.com)